









**LEVER HANDLES EN**





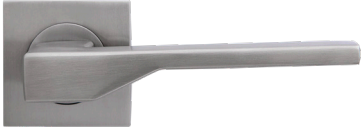
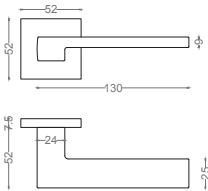
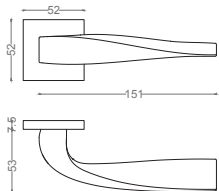
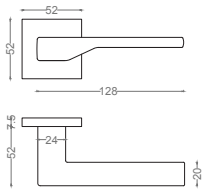

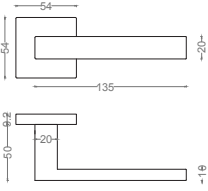
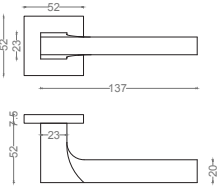
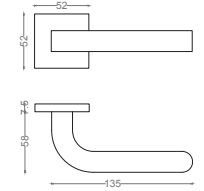
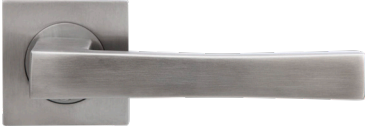
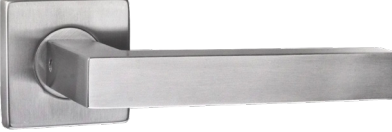
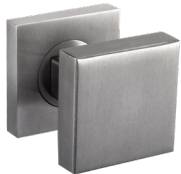
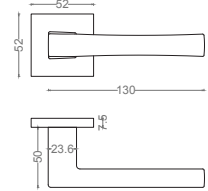
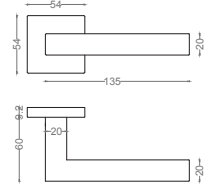
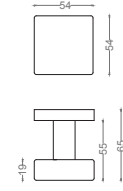

## HOLLOW OR SOLID STAINLESS STEEL LEVER HANDLES ON ROUND OR SQUARE LEVER ROSE & CYLINDER ROSE.



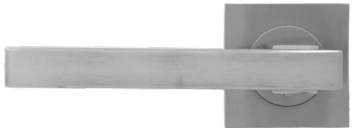
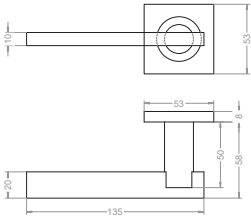
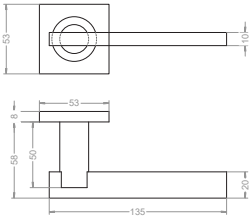
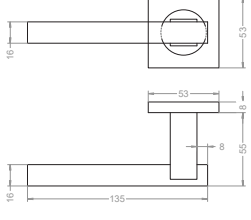
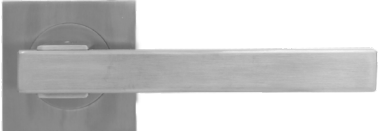

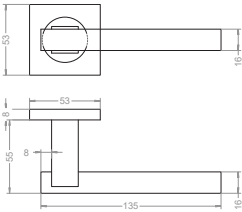
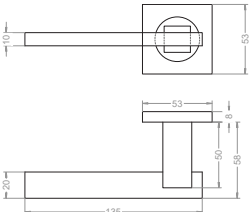
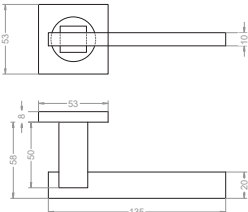



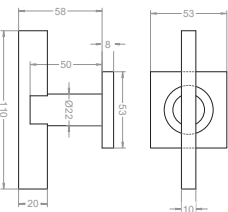
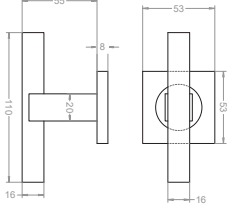
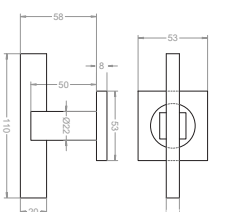

### Features:

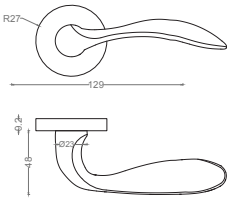
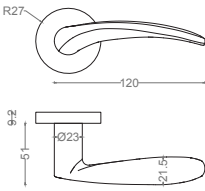
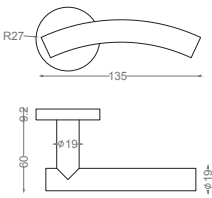



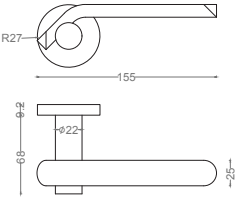
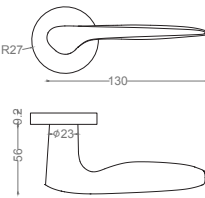
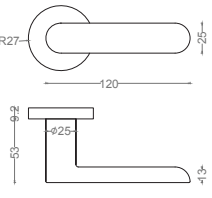

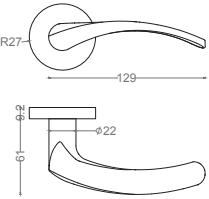
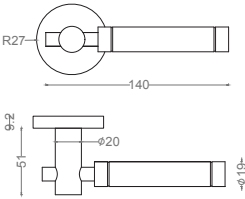
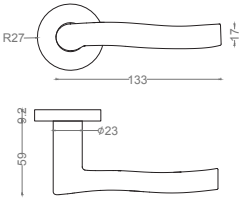

- Stainless steel lever handle set on lever rose with cylinder rose. Fully return spring assisted lever handle. The cylinder rose and lever rose features concealed fixing via an easy click.
- Material: stainless steel EN 1.4301 (type SUS304), optional in EN 1.4401 (type SUS316).
- Optional: Anti-bacterial coating.
- Door thickness: up to 50 mm (for doors thickness more than 50 mm please specify while ordering).
- Several options of cylinder rose types. Escutcheons/cylinder roses are supplied separately.
- Standard finish: Satin Stainless Steel (SSS). Other finishes are available upon request.



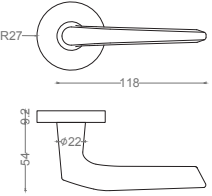
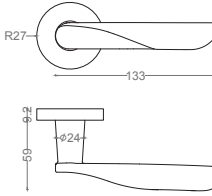
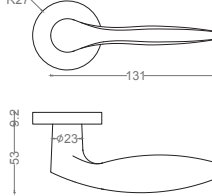



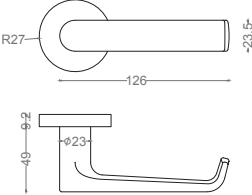
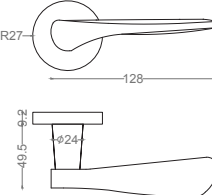
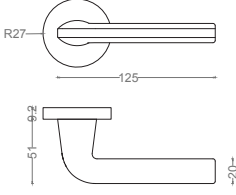
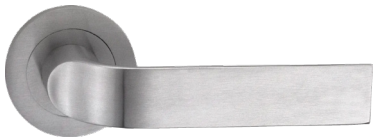

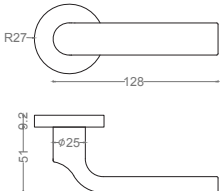
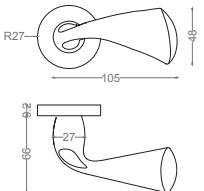
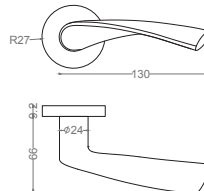

AVAILABLE FINISHES	
MATT BLACK/US10B	POLISHED STAINLESS STEEL
	
PVD SATIN BRASS	
	

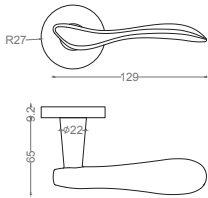
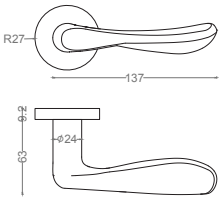
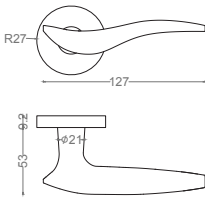



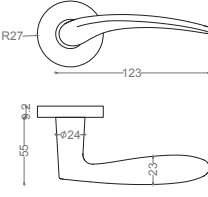
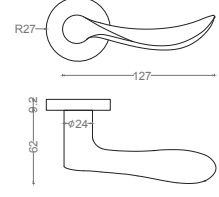
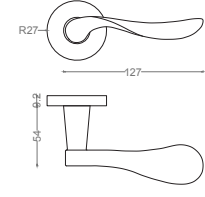



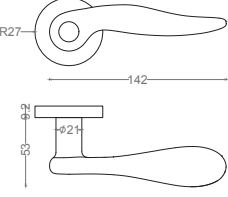
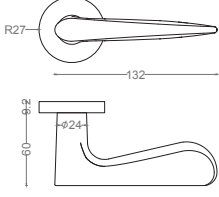
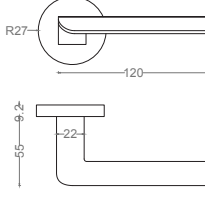

SOLID – HS3003Q	SOLID – HS3004Q	SOLID – HS3005Q
		
		
HOLLOW – HT3008Q	SOLID – HS3028Q	SOLID – HS3036Q
		
		
SOLID – HS3044Q	HOLLOW – HH3043Q	HOLLOW – KH3047Q
		
		

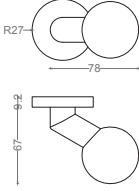
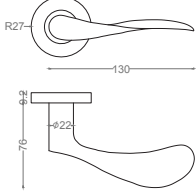
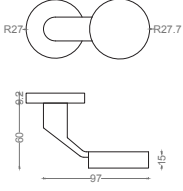
<p><b>H54-S-DINL SSS</b></p> 	<p><b>H54-S-DINR SSS</b></p> 	<p><b>H55-S-DINL SSS</b></p> 
		
<p><b>H55-S-DINR SSS</b></p> 	<p><b>H56-S-DINL SSS</b></p> 	<p><b>H56-S-DINR SSS</b></p> 
		
<p><b>THQ54-S SSS</b></p> 	<p><b>THQ55-S SSS</b></p> 	<p><b>THQ56-S SSS</b></p> 
		



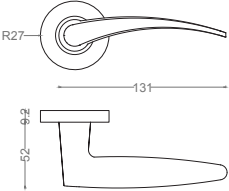
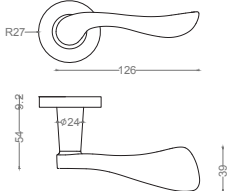
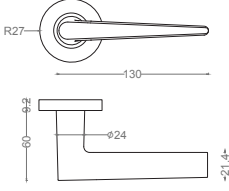



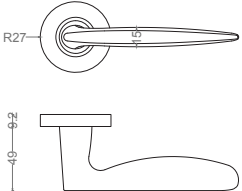
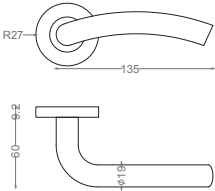
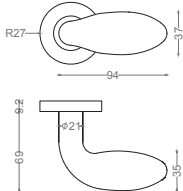



SOLID - HS3001	SOLID - HS3002	HOLLOW - HT3007
		
		
SOLID - HS3009	SOLID - HS3010	SOLID - HS3011
		
		
SOLID - HS3012	SOLID - HS3013	SOLID - HS3014
		
		

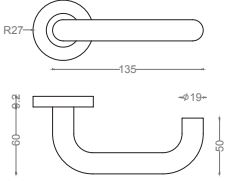
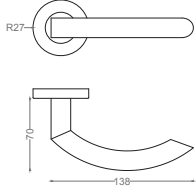
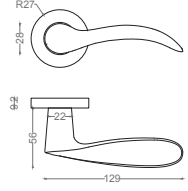



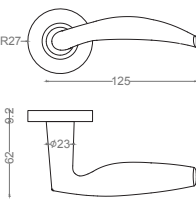
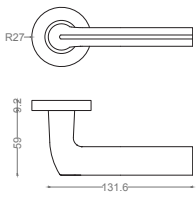
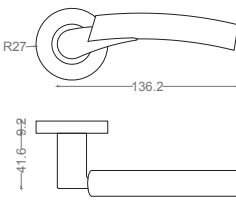



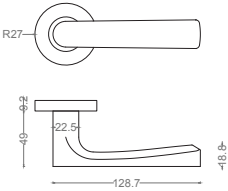
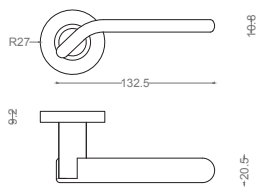
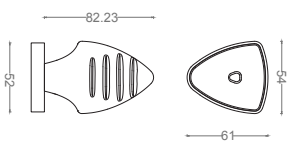

SOLID – HS3015	SOLID – HS3057	SOLID – HS3017
		
		
SOLID – HS3018	SOLID – HS3019	SOLID – HS3020
		
		
SOLID – HS3021	SOLID – HS3022	SOLID – HS3023
		
		

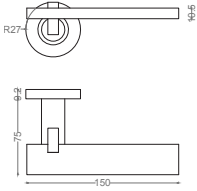
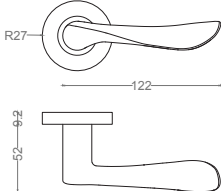
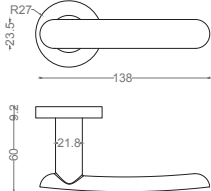



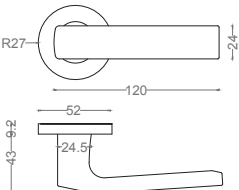
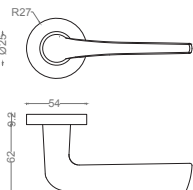
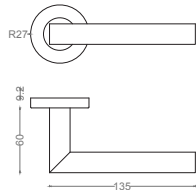

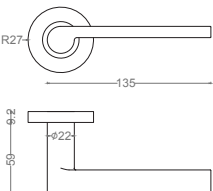
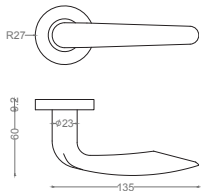
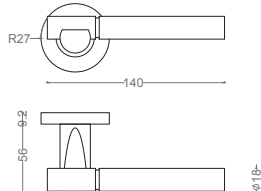

SOLID – HS3024	SOLID – HS3025	SOLID – HS3026
		
		
SOLID – HS3027	SOLID – HS3029	SOLID – HS3031
		
		
SOLID – HS3032	SOLID – HS3033	SOLID – HS3035
		
		



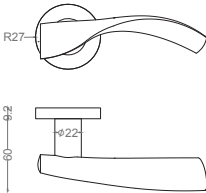
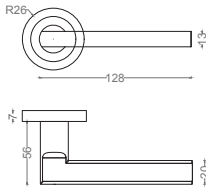
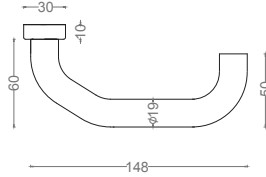



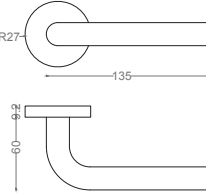
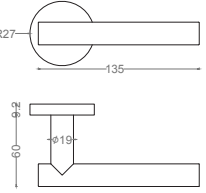
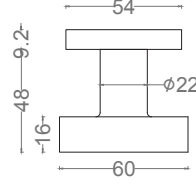

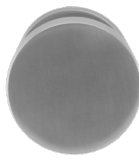
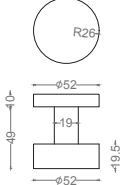
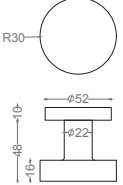

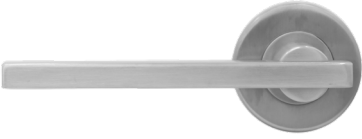
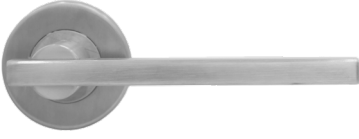
SOLID – KS3034	SOLID - HS3039	SOLID – KS3040
		
		
SOLID – HS3041	SOLID – HS3042	SOLID – HS3059
		
		
SOLID - HS3066	HOLLOW - H04	SOLID – HS3046
		
		

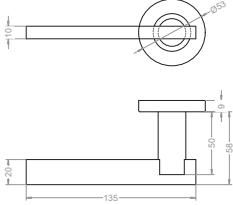
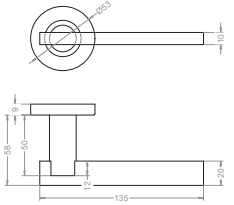
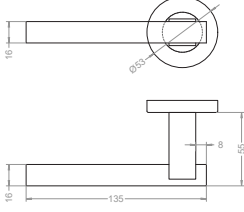

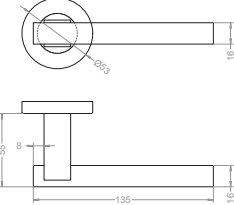
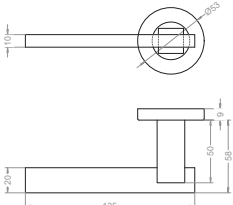
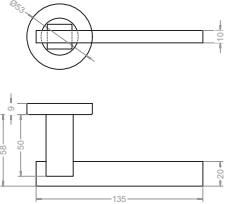

HOLLOW – H01B01	HOLLOW – HL42	SOLID – HS3050
 <p><b>EN1634-1</b></p>		
		
SOLID – HS3051	SOLID – HS3060	SOLID – HS3061
		
		
SOLID – HS3053	SOLID – HS3056	HOLLOW – KH3049
		
		



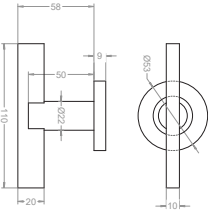
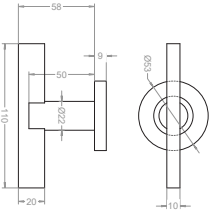
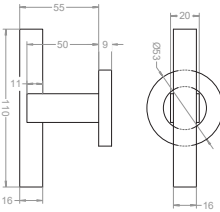



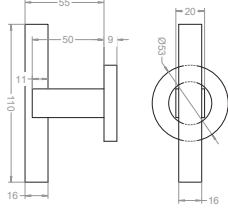
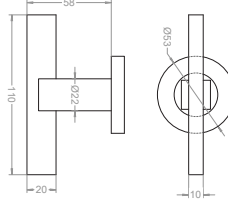
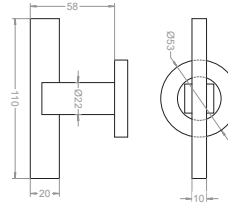

SOLID – HS3058	SOLID – HS3063 (H65)	SOLID – HS3052
		
		
SOLID – HS3054	HOLLOW – HT3068 (H14)	HOLLOW – HL2B01
		
		
SOLID – H60B01	HOLLOW – HT3067	SOLID – H16
		
		

<p><b>SOLID – H61</b></p>	<p><b>SOLID - H34B01-E1 (Available with threaded rose and escutcheon)</b></p>	<p><b>HOLLOW - HT1036CR (Available with oval rose and escutcheon)</b></p>
		
		
<p><b>HOLLOW - H02B01</b></p>	<p><b>HOLLOW - HT2B01</b></p>	<p><b>HOLLOW – LK2X (ROTATING SPINDLE, FIXED KNOB)</b></p>
		
		
<p><b>HOLLOW – KH3006</b></p>	<p><b>SOLID – KS3030</b></p>	
		
		

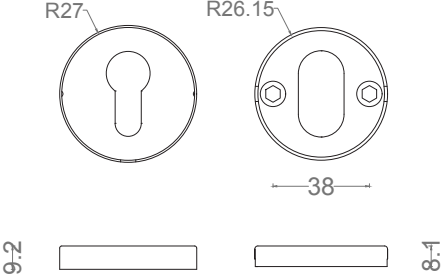

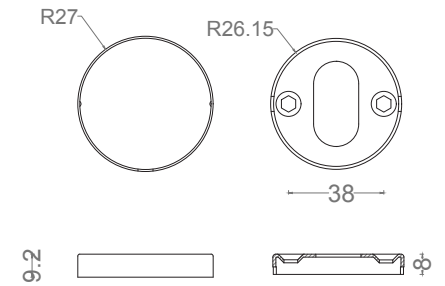

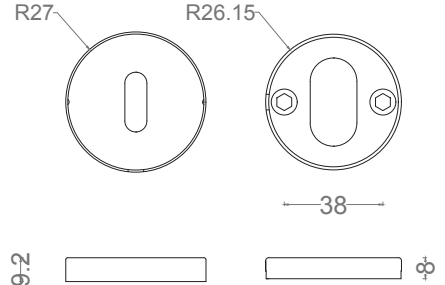

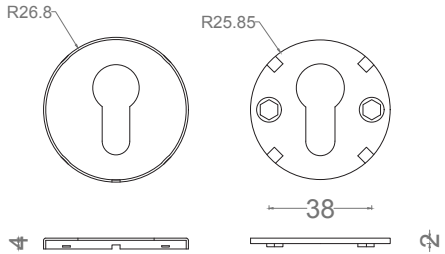

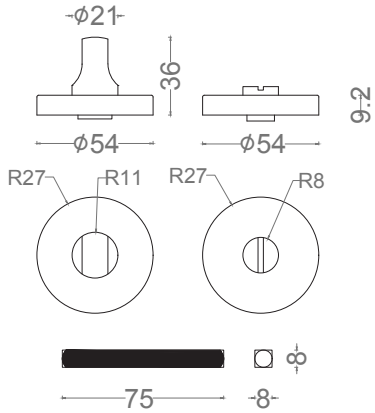

H54-R-DINL SSS	H54-R-DINR SSS	H55-R-DINL SSS
		
		
H55-R-DINR SSS	H56-R-DINL SSS	H56-R-DINR SSS
		
		
THQ54-R-DINR SSS	THQ54-R-DINL SSS	THQ55-R-DINL SSS
		
		

THQ55-R-DINR SSS	THQ56-R-DINL SSS	THQ56-R-DINR SSS
		
		

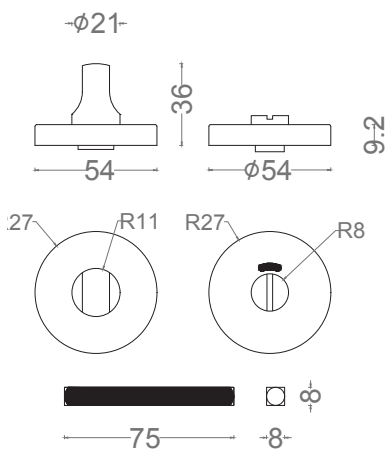
**ITEM CODE: ESCUTCHEONS TYPES.**

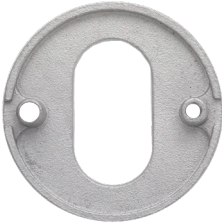
		<b>B01.E1</b>
		
		<b>B01.E0</b>
		
		<b>B01.E3</b>
		
		<b>B01.E1.4</b>
		

ITEM CODE: ESCUTCHEONS TYPES.

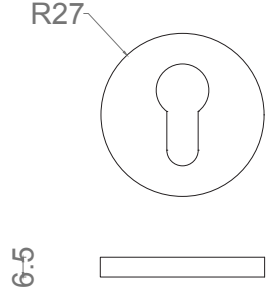

		T01E01X-9.2
		
		
		
		

ITEM CODE: ESCUTCHEONS TYPES.

		B01.E1.COU4L
		B01Q.E1
		B01Q.E0

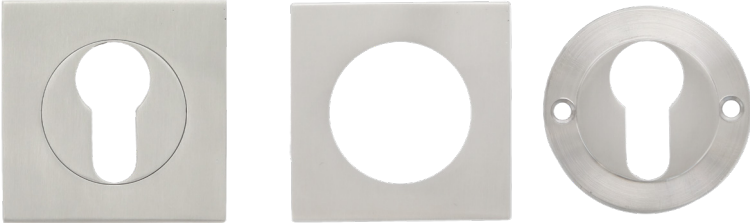
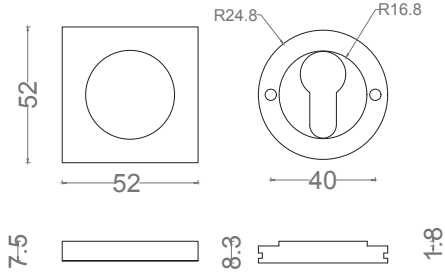
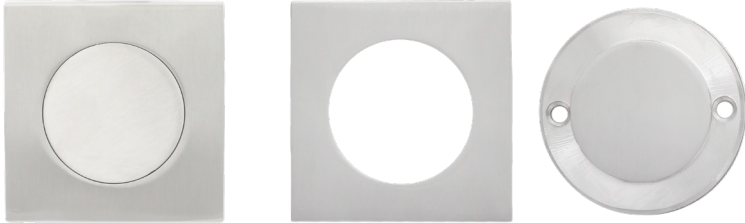
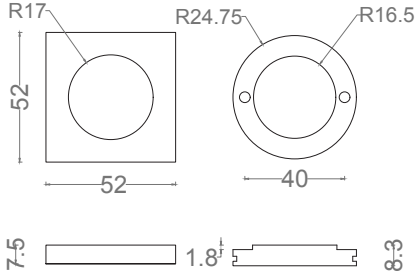

ITEM CODE: ESCUTCHEONS TYPES.

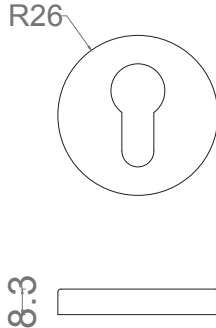
<b>BS01Q.E1</b>		
		
<b>B01Q</b>		
		
<b>BA01.E1</b>		
		





ITEM CODE: ESCUTCHEONS TYPES.

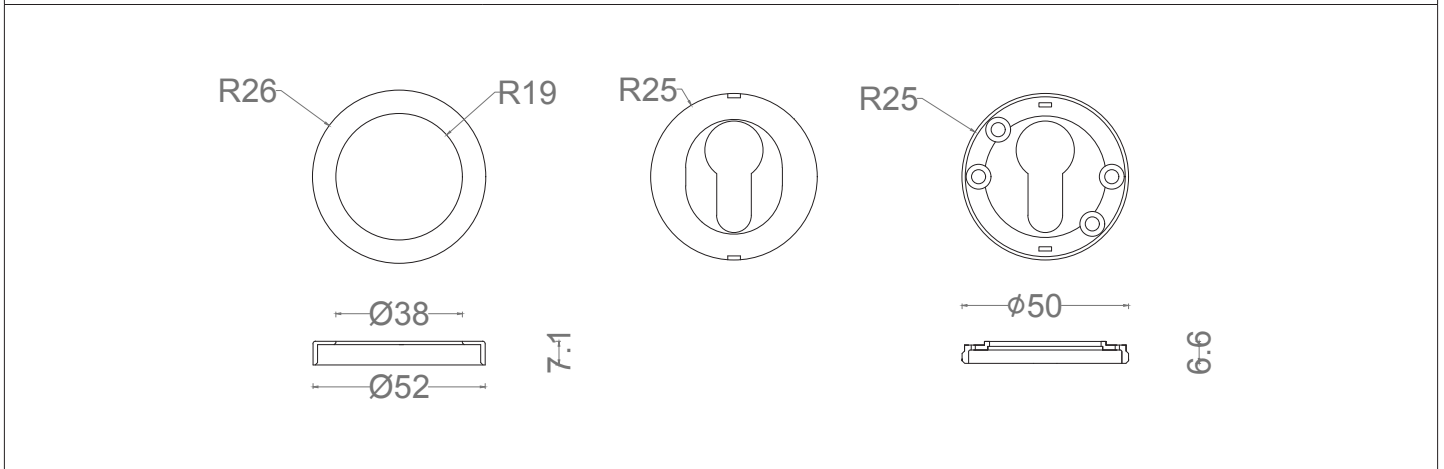

**BS01.E1 D52X7 (THREADED TYPE)**

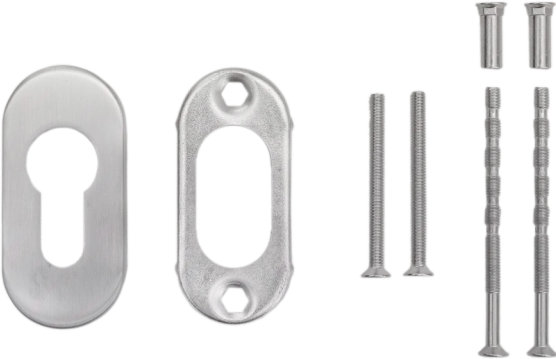
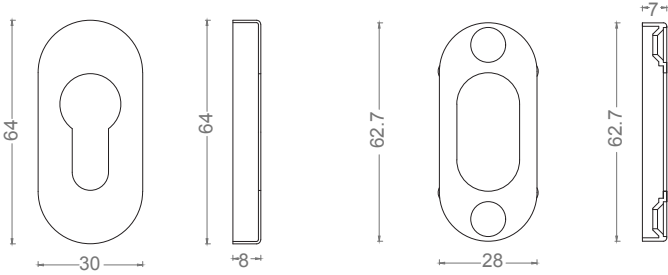

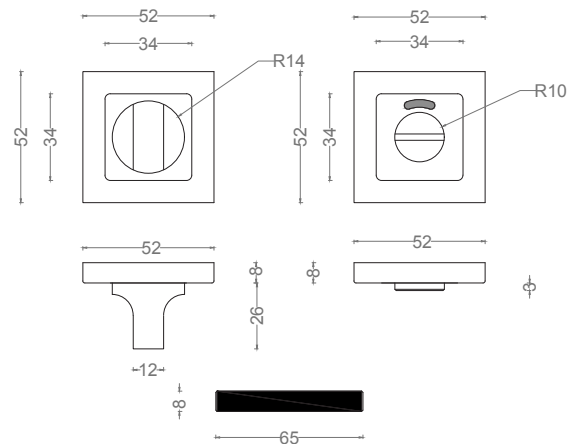
ITEM CODE: ESCUTCHEONS TYPES.

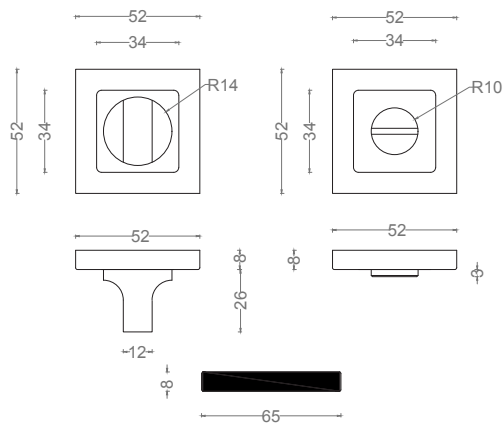
	<p style="text-align: center;"><b>B22E1</b></p> 
	<p style="text-align: center;"><b>T07JQ-I01</b></p> 
	<p style="text-align: center;"><b>T07JQ01</b></p> 

ITEM CODE: ESCUTCHEONS TYPES.

	<b>T01B01-8</b>
	<b>T01E01-8</b>

**ITEM CODE: H01B32.E1**

**STAINLESS STEEL HOLLOW lever handle ON square backplate.**

Features:

- Description: Stainless steel lever handle set on square backplate. Fully return spring assisted lever handle.
- Material: stainless steel EN 1.4301 (type SUS304), optional in EN 1.4401 (type SUS316).
- Door thickness: 35 mm to 70 mm (for doors thickness more than 70 mm please specify while ordering).
- 1 pair of lever handles on backplate 170 x 170 x 1.5 mm, 1 piece of 8 x 105 mm square solid spindle.
- 1 pc. of Allen key, 8 pcs wooden screws
- Standard finish: Satin Stainless Steel (SSS). Other finishes are available upon request.

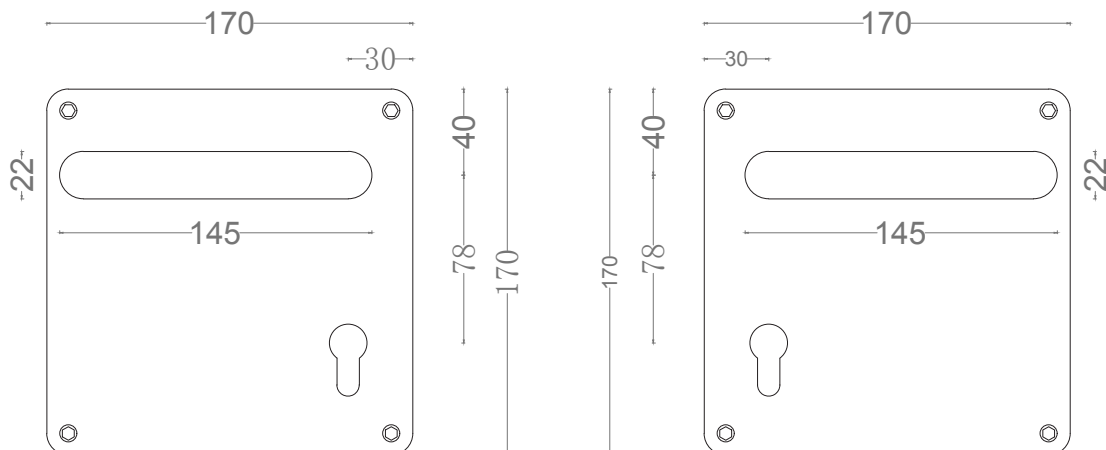

**ITEM CODE: H01B03T1-78L**

**STAINLESS STEEL HOLLOW lever handle ON BACKPLATE.**

Features:

- Description: Stainless steel hollow lever handle set on backplate 170 x 170 x 1.5 mm with turn and release & indicator. Fully return spring assisted lever handle.
- Material: stainless steel EN 1.4301 (type SUS304), optional in EN 1.4401 (type SUS316).
- Door thickness: 35 mm to 45 mm (for doors thickness more than 45 mm please specify while ordering).
- Centre to centre: 78 mm
- Left handed.
- 1 pair of lever handles dia. 22 x 145 mm, 1 piece of 8 x 58 mm square solid spindle.
- 1 pc. of Allen key, 8 pcs wooden screws
- Standard finish: Satin Stainless Steel (SSS). Other finishes are available upon request.

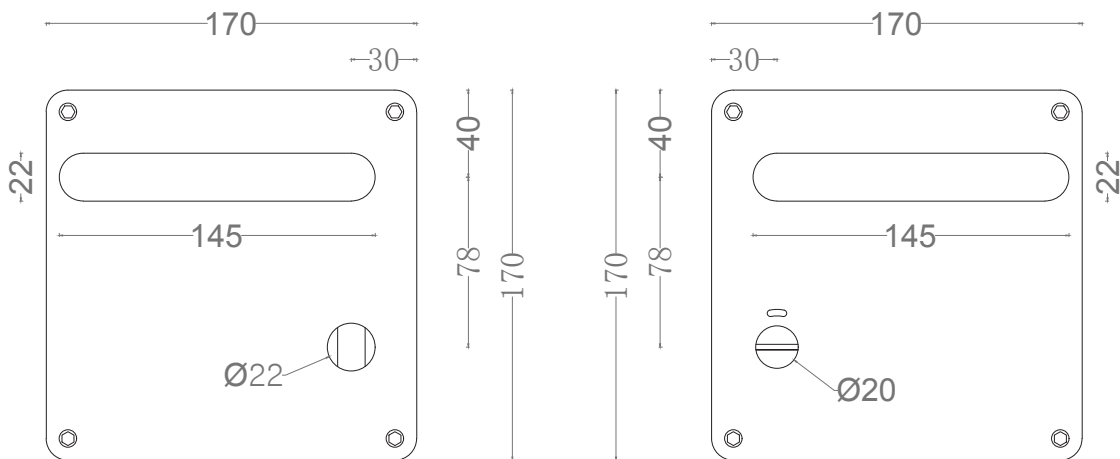
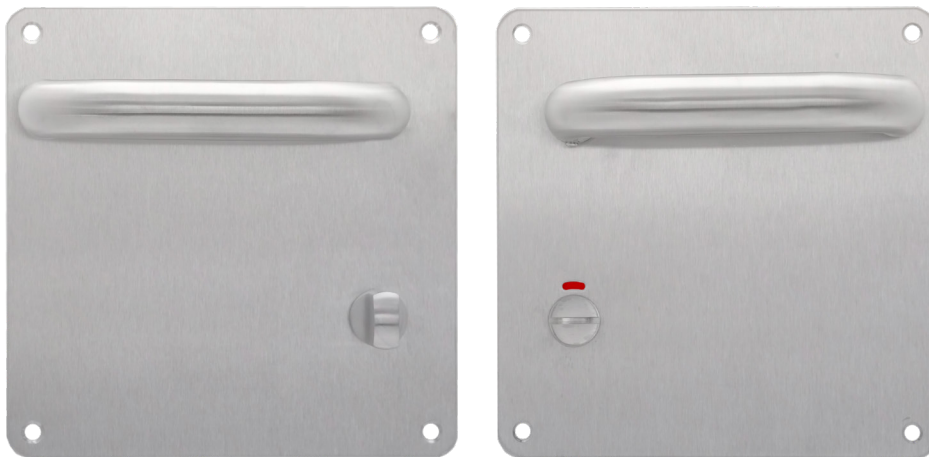

**ITEM CODE: H01B03T1-78R**

**STAINLESS STEEL HOLLOW lever handle ON BACKPLATE.**

Features:

- Description: Stainless steel hollow lever handle set on backplate 170 x 170 x 1.5 mm with turn and release & indicator. Fully return spring assisted lever handle.
- Material: stainless steel EN 1.4301 (type SUS304), optional in EN 1.4401 (type SUS316).
- Door thickness: 35 mm to 45 mm (for doors thickness more than 45 mm please specify while ordering).
- Centre to centre: 78 mm
- Right handed.
- 1 pair of lever handles dia. 22 x 145 mm, 1 piece of 8 x 58 mm square solid spindle.
- 1 pc. of Allen key, 8 pcs wooden screws
- Standard finish: Satin Stainless Steel (SSS). Other finishes are available upon request.

