

ITEM CODE: SERIES 4100 & 4000

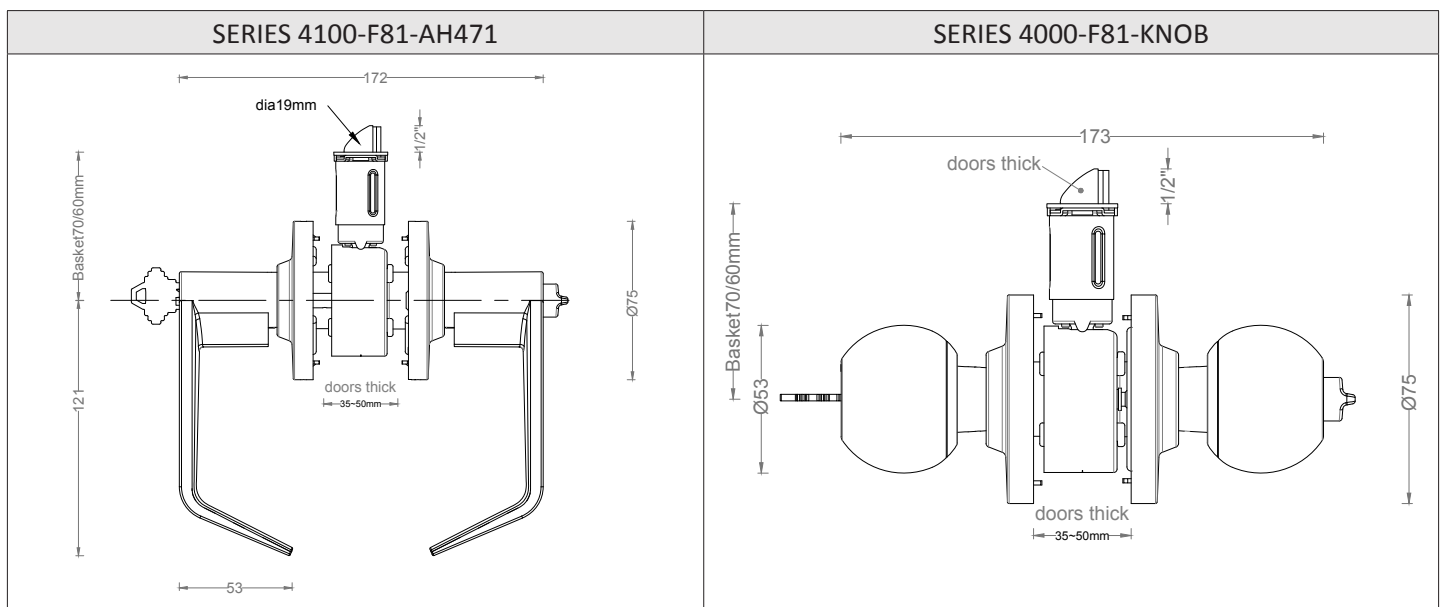

Features:



- Heavy duty cylindrical bored locks.
- UL listed. UL10C 3 hours fire rated.
- Compliant to meet ANSI A156.2 grade 2.
- ADA compliant (American with Disabilities Act), ANSI A117 (Accessible and Usable Buildings and Facilities).
- Non-handed for simple installation.
- Series 4100: Standard accepts SFIC core. Optional key-in-lever.
- Series 4000: Standard key-in-lever.
- Designed for doors thickness 44 mm standard.
- Standard backset: 70 mm only.
- Latchbolt 12.7 mm throw in stainless steel.
- Strike: ANSI strike.
- Available in knob or lever handle.
- Series 4100 material base: lever is zinc, rose is SUS304.
- Series 4000 material base: SUS304
- Cylinders and keys: Small format Interchangeable core (SFIC) cylinders, 6 or 7 pins SFIC cylinders with 2 operate nickel plated standard keys + 1 nickel plated control key.
- SFIC core on selected models, several ANSI functions are available
- Construction keys, master key and keyways are available.
- Standard finish: 626 (satin chromium plated) standard, Other finishes are available upon request.

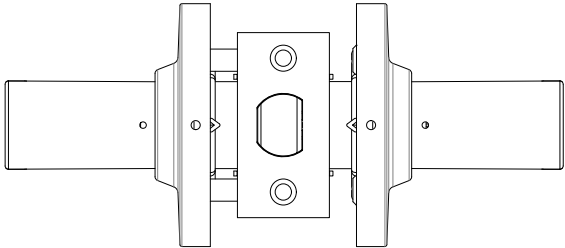
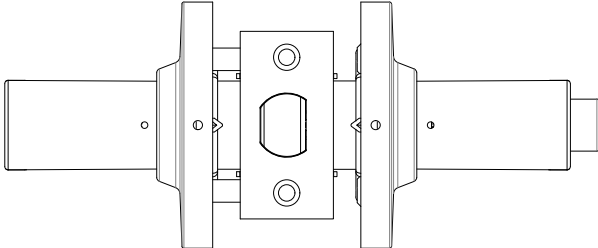
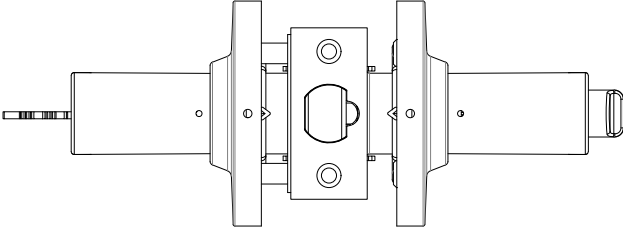
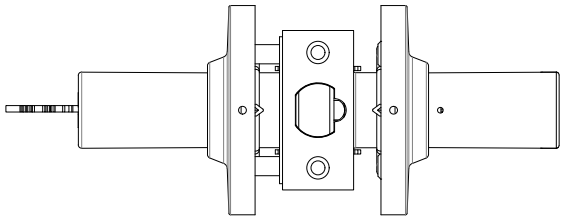
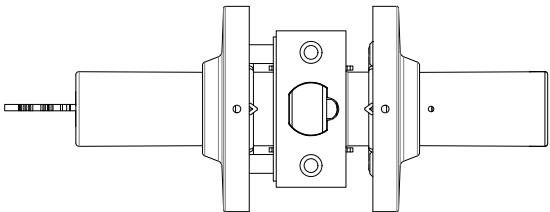
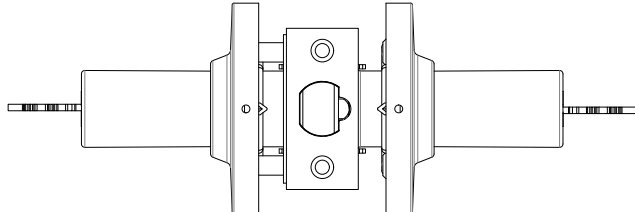

OUTSIDE/INSIDE - PASSAGE (ANSI F75)	OUTSIDE/INSIDE – PRIVACY (ANSI F76)
	
<ul style="list-style-type: none"> • Both lever always unlocked 	<ul style="list-style-type: none"> • Push-button locking • Can be opened from outside with small narrow tool • Turning the inside lever releases button
OUTSIDE/INSIDE – ENTRY (F81)	OUTSIDE/INSIDE – CLASSROOM (F84)
	
<ul style="list-style-type: none"> • Outside lever locked and unlocked by key or by turn-button on inside lever • Inside lever always unlocked • SFIC & Key-in cylinder are available for 4100 series 	<ul style="list-style-type: none"> • Outside lever locked and unlocked by key • Inside lever always unlocked • SFIC & Key-in cylinder are available for 4100 series
OUTSIDE/INSIDE – STOREROOM (F86)	OUTSIDE/INSIDE - COMMUNICATING (F80)
	
<ul style="list-style-type: none"> • Outside lever fixed • Entrance by key only • Inside lever always unlocked • SFIC & Key-in cylinder are available for 4100 series 	<ul style="list-style-type: none"> • Deadlocking latchbolt operated by lever from either side. • Turning key in either lever locks or unlocks its own lever independently.

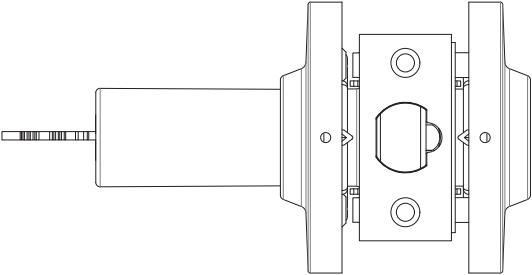
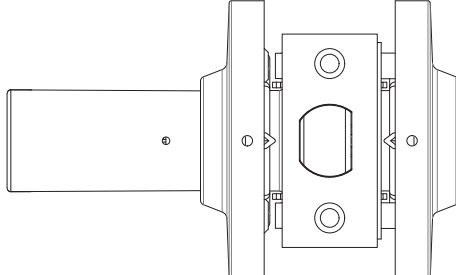
CYLINDRICAL BORED LOCKS

INSIDE / OUTSIDE - EXIT WITH SFIC - CONNECTING ROOM	INSIDE / OUTSIDE - EXIT WITHOUT SFIC - CONNECTING ROOM
	
<ul style="list-style-type: none"> • The inside lever is locked or unlocked by key. • When unlocked the lockset provides Exit. • When locked, the lockset stops Exit. • Blank plate outside. 	<ul style="list-style-type: none"> • Deadlocking latchbolt operated from inside only. • Blank plate outside.

DSSD	DDSD
	

DOIB	AVAILABLE TRIM: AH471
