



MORTISE LOCKS
SERIES 1000L

ITEM CODE: DML1000L RANGE





Features:

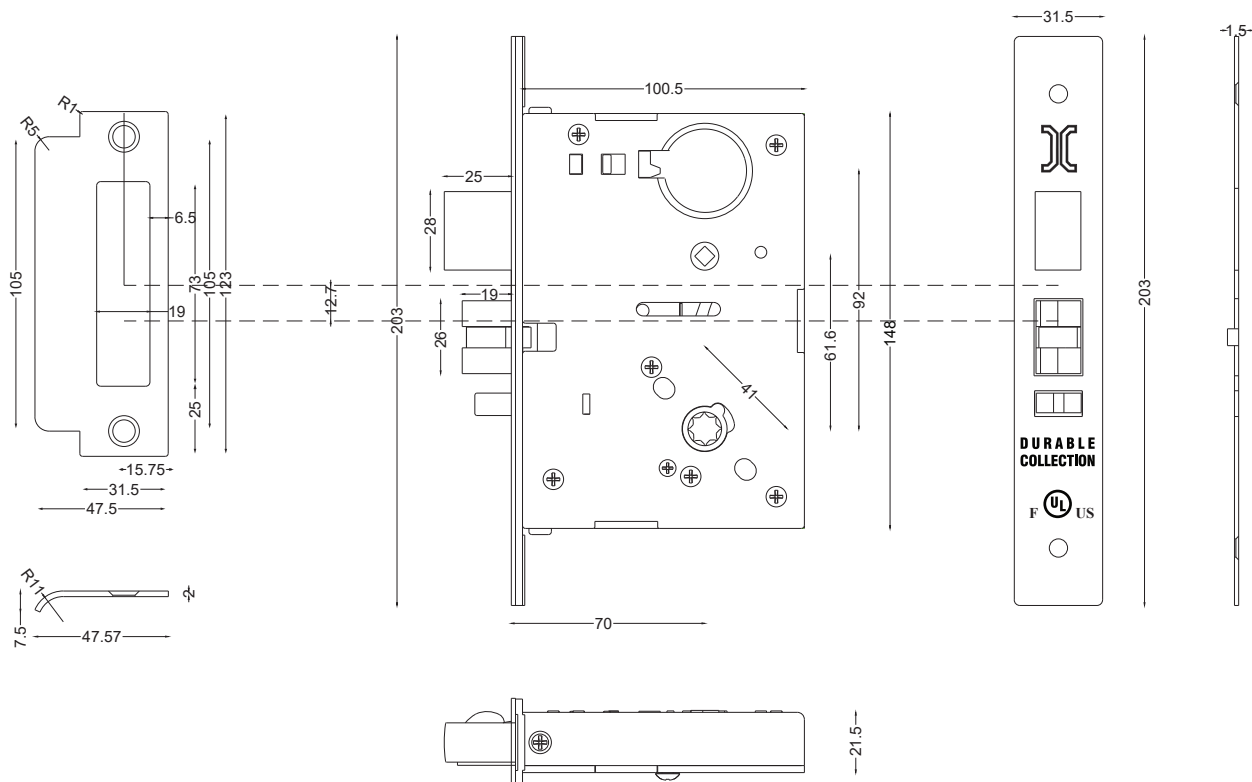

- Heavy duty mortise locks, UL listed. UL10C 3 hours fire rated.
- Tested to meet ANSI A156.13 grade 1 (1,000,000 cycles), series 1000.
- ADA compliant (American with Disabilities Act), ANSI A117 (Accessible and Usable Buildings and Facilities).
- BHMA CERTIFIED.
- Lockcase: Heavy duty steel with zinc dichromate finish for corrosion resistance.
- Designed for doors thickness 44 mm standard. Specify if doors thickness is more than 44 mm.
- Field reversible without lock disassembly.
- Backset: 70 mm, Center to center: 92 mm, Armored front size: 203 x 32 x 1.5 mm, Case size: 104 x 148 x 21.5 mm.
- Deadbolt: 25 mm in stainless steel. Latchbolt 19 mm throw in stainless steel with anti-friction tongue.
- Strike: ANSI curved lip strike 32 x 124 mm with dust box standard.
- Tested with levers in hollow or solid stainless steel.
- Cylinders and keys: Mortise or interchangeable core (SFIC or LFIC) cylinders. 5 or 6 pins mortise cylinders with 3 brass standard keys (computer key is available). 6 or 7 pins (SFIC or LFIC) cylinders with 2 operate nickel plated standard keys + 1 nickel plated control key.
- Several cams, construction keys, master key system and keyways are available.
- Standard finish: 630 (satin stainless steel). Other finishes are available upon request.

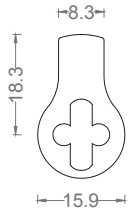
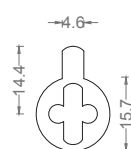
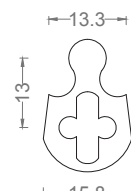
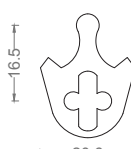

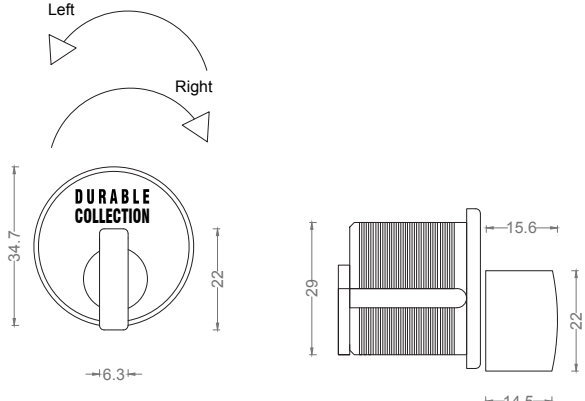
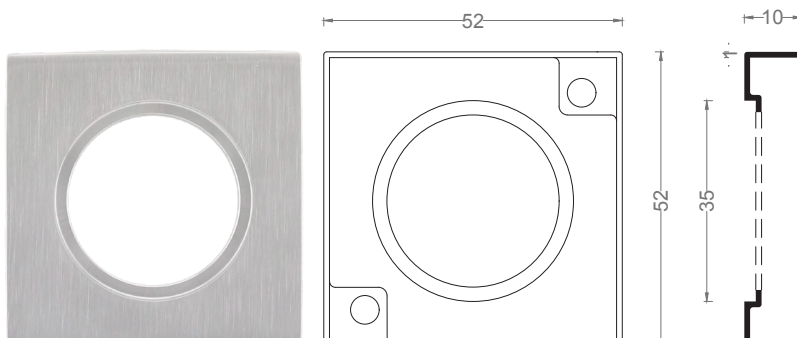
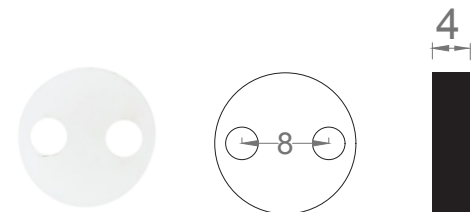
SFIC HOUSING – CICH – 6 or 6/7 PINS SFIC		SFIC CORE – SFIC – 6 & 7 PINS		MORTISE CYLINDER – DMC	
CYLINDER GUARD – DCG – AVAILABLE 5, 10 & 16 MM PROJECTION					
KEYS DMC		WAVE SPRING		KEYS SFIC	
SECURITY CYLINDER GUARD – DCG8.5 or DCG13.5			CYLINDER GUARD – DCG8		
CAMS FOR SFIC HOUSING					
1	2	3	4	5	6

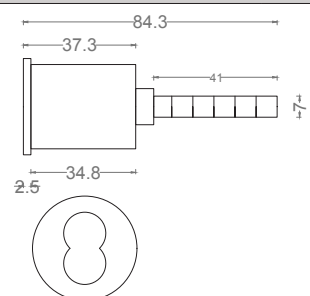
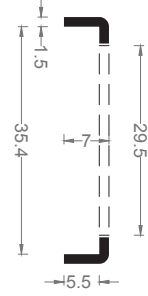
CAMS FOR DMC HOUSING			
1	2	4	MB
			
ONE WAY CYLINDER – DMCTL (LEFT) or DMCTR (RIGHT)			
			
SQUARE CYLINDER GUARD – DCGSQ		SPACER SFIC 6 PINS – FOR CICH – FOR SFIC 7 PINS TO SFIC 6 PINS	
			
CICHR34.9 T, RIM CYLINDER WITH SFIC HOUSING		DCG	
			

MORTISE LOCKS SERIES 1000L

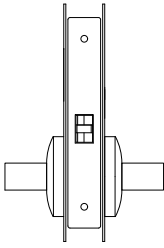
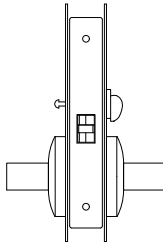
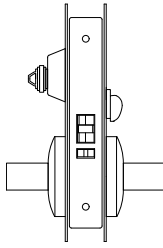
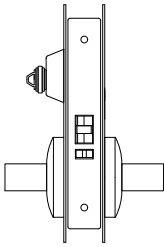
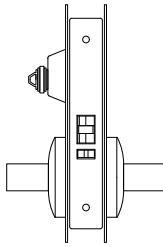
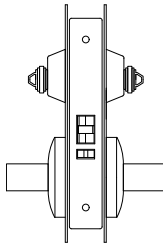



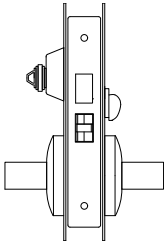
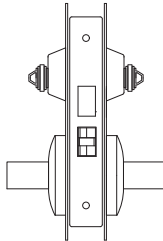
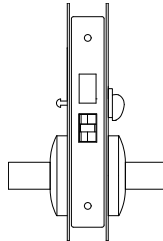

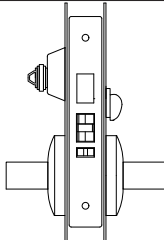

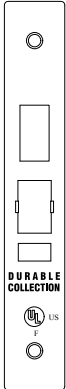
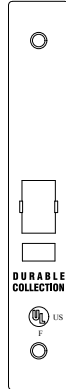
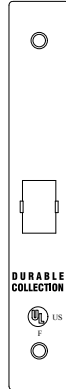
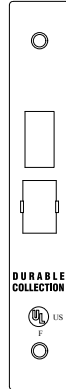

OUTSIDE / INSIDE PASSAGE OR CLOSET LATCH (ANSI F01) -DML1001L	OUTSIDE / INSIDE PRIVACY, BEDROOM OR BATH LOCK (ANSI F22) - DML1022L	OUTSIDE / INSIDE ENTRY LOCK (ANSI F04)-DML1004L
		
<p>Latch bolt operated by lever from either side at all times.</p>	<p>Latch bolt operated by lever from either side except when outside lever is locked by inside turn or button. Operating inside lever, closing door or operating outside emergency release unlocks outside lever.</p>	<p>Latch bolt operated by lever from either side except when outside lever is made inoperative by a stop or mechanical means other than key. When outside lever is locked, latch bolt is retracted by key from outside or by operating inside lever. Auxiliary dead latch.</p>
OUTSIDE / INSIDE CLASSROOM LOCK (ANSI F05)-DML1005L	OUTSIDE / INSIDE STOREROOM OR CLOSET LOCK (ANSI F07)-DML1007L	OUTSIDE / INSIDE APARTMENT, EXIT OR PUBLIC TOILET LOCK (ANSI F09)-DML1009L
		
<p>Latch bolt operated by lever from either side except when outside lever or knob is locked from outside by key. When outside lever is locked, latch bolt is retracted by key, or by operating key and outside lever from outside or by operating inside lever. Auxiliary dead latch.</p>	<p>Latch bolt operated by key from outside or by operating inside lever. Outside lever is always inoperative. Auxiliary dead latch.</p>	<p>Latch bolt operated by lever from either side, except when outside lever is locked by key from inside. When outside lever is locked, latch bolt is retracted by key from outside or by operating inside lever. Auxiliary dead latch.</p>

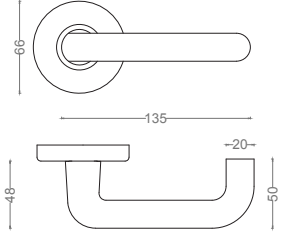
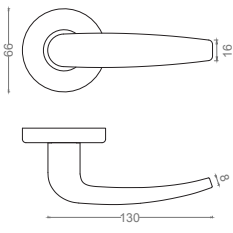
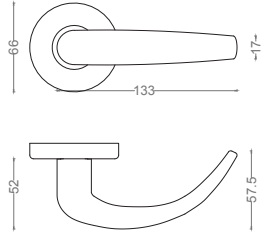

MORTISE LOCKS SERIES 1000L

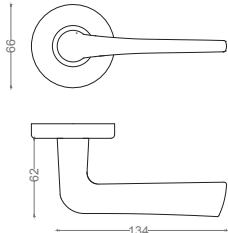
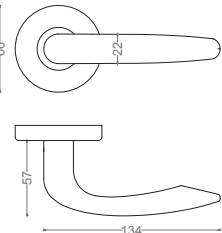
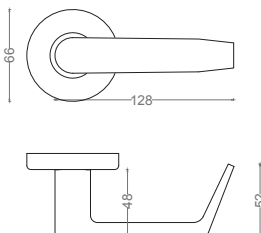
OUTSIDE / INSIDE DORMITORY OR EXIT LOCK (ANSI F13)- DML1013L	OUTSIDE / INSIDE STORE DOOR LOCK (ANSI F14)-DML1014L	OUTSIDE / INSIDE PRIVACY, BEDROOM, BATH LOCK (ANSI F19)- DML1019L
		
<p>Latch bolt operated by lever from either side. Dead bolt projected by key from outside and turn from inside. Operating inside lever retracts both bolts and unlocks outside.</p>	<p>Latch bolt operated by lever from either side. Dead bolt operated by key from either side.</p>	<p>Latch bolt operated by lever from either side. Dead bolt operated by turn from inside and emergency release from outside. Operating inside lever retracts both bolts.</p>

OUTSIDE / INSIDE APARTMENT CORRIDOR DOOR (ANSI F20)-DML1020L	
	<p>Latch bolt operated by lever from either side, except when outside lever is made inoperative by a stop or mechanical means other than key. Dead bolt operated by key outside or turn inside. Key outside operates both bolts. Operating inside lever retracts both bolts and outside remains locked. Latch bolt is deadlocked when outside lever is made inoperative or when the dead bolt is projected. When dead bolt is retracted, lever is unlocked by stop or mechanical means other than key.</p>

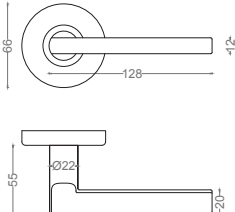
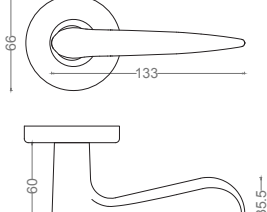
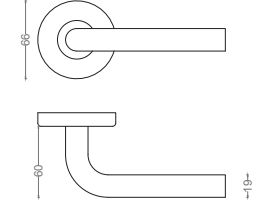
FOREND/FACEPLATE			
DML1020L	DML1004L, DML1005L, DML1007L, DML1009L	DML1001L, DML1022L	DML1013L, DML1014L, DML1019L
			

LEVER DESIGN - GRADE 1		
AH100 ANSI-SOLID	AH101 ANSI-SOLID	AH102 ANSI-SOLID
		
		
AH103 ANSI-HOLLOW	AH104 ANSI-HOLLOW	AH105 ANSI-SOLID
		
		
AH106 ANSI-SOLID	AH108 ANSI-SOLID	AH109 ANSI-HOLLOW
		
		

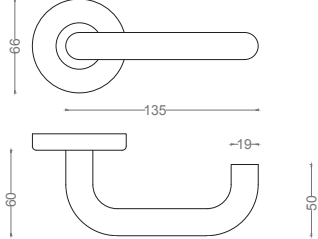
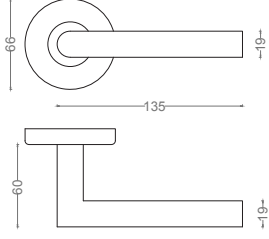
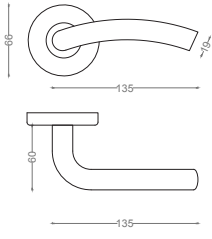
LEVER DESIGN - GRADE 1		
AH110 ANSI-HOLLOW	AH111 ANSI-HOLLOW	AH112 ANSI-HOLLOW
		
		
AH113 ANSI-SOLID		
